



■ Vers. 064



■ Vers. 064







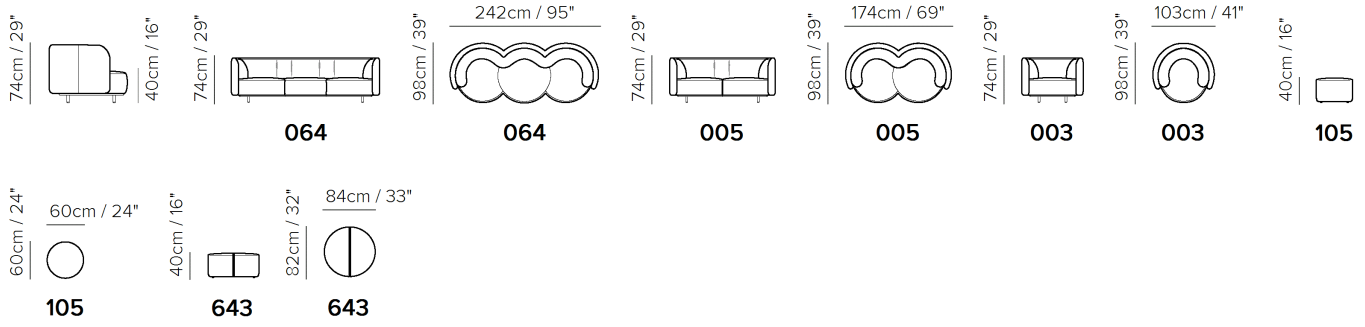

■ Vers. 005+003

SCHEMATICS



TECHNICAL INFORMATION

	COVERING	Leather <input checked="" type="checkbox"/>	Soft Cover <input checked="" type="checkbox"/>			
	LEGS	Wood <input type="checkbox"/>	Metal <input checked="" type="checkbox"/>	Plastic <input type="checkbox"/>	Castors <input type="checkbox"/>	Upholstered <input type="checkbox"/>
	FILLING	Arms <input type="checkbox"/> Fiber <input checked="" type="checkbox"/> Foam <input type="checkbox"/> Feather/Fiber Mix <input type="checkbox"/> Feather	Seat cushion <input type="checkbox"/> Fiber <input checked="" type="checkbox"/> Foam <input type="checkbox"/> Feather/Fiber Mix <input type="checkbox"/> Feather	Back cushion <input type="checkbox"/> Fiber <input checked="" type="checkbox"/> Foam <input type="checkbox"/> Feather/Fiber Mix <input type="checkbox"/> Feather		
	COMFORT	Firm Comfort <input type="checkbox"/>	Standard Comfort <input checked="" type="checkbox"/>			
	FUNCTION	Bed <input type="checkbox"/>	Electric motion <input type="checkbox"/>	Motion <input type="checkbox"/>	Recliner <input type="checkbox"/>	Sliding <input type="checkbox"/>
	OPTIONS	Removable <input type="checkbox"/>	Nails <input type="checkbox"/>	Contrast Stitching <input type="checkbox"/>		

NOTES

- Designer: Nika Zupanc
- Magazine Rack Voyage (T845) is a unique element that can be positioned on the ground next to the seat, or integrated into the Pouf and Ottoman versions of the 3201 Wave model.
- EUCAFEEL® is the innovative solution offers many benefits: Best moisture regulation, ideal warmth control, first class pressure relief and high elasticity. The distinctive EUCAFEEL high density polyurethane foam, thanks to its specially developed formulation, has maximum breathability and maximum comfort.
- Tight Seat Cushion (the seat cushions of the models are fixed to the frame)
- Tight Back Cushion (the back cushions of the models are fixed to the frame)
- Wood Frame
- Without Feet Assembled (the feet will be in a bag inside the package)
- Plastic Wrap (the model will be wrapped in a plastic bag)
- Feet available in metal finishing 88 (Light Gold)
- Feet height 11,0 cm

NOTES
