



■ Vers. 272+274



■ Vers. 272+274



■ Vers. 272+274



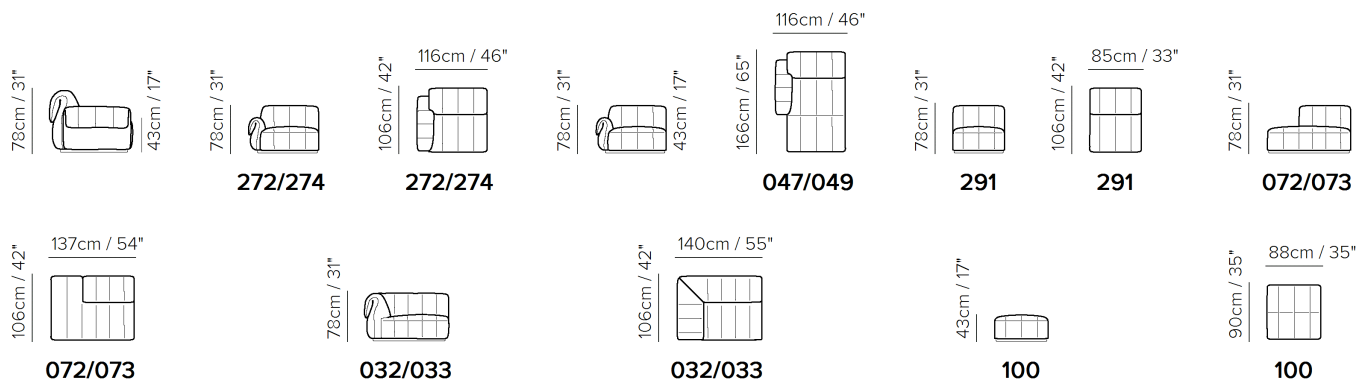

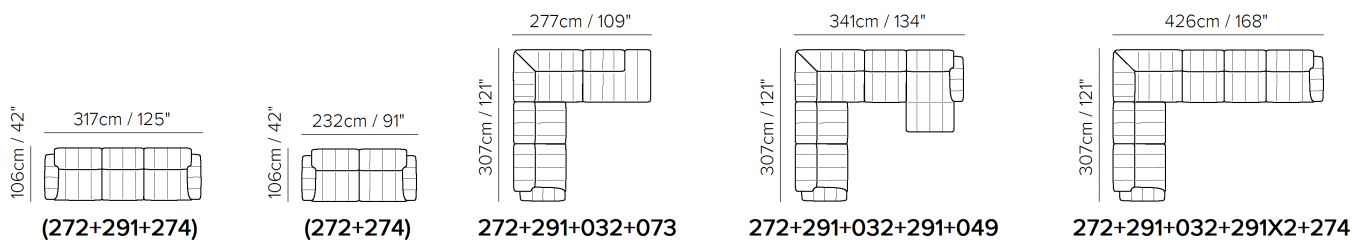

SCHEMATICS



COMPOSITION EXAMPLES



TECHNICAL INFORMATION

	COVERING	Leather <input checked="" type="checkbox"/>					
	LEGS	Plastic <input type="checkbox"/>	Wood <input type="checkbox"/>	Metal <input checked="" type="checkbox"/>	Metal <input checked="" type="checkbox"/>	Upholstered <input type="checkbox"/>	
		Castors <input type="checkbox"/>					
	FILLING	Arms	<input type="checkbox"/> Fiber <input checked="" type="checkbox"/> Foam <input type="checkbox"/> Feather/Fiber Mix <input type="checkbox"/> Feather	Seat cushion	<input type="checkbox"/> Fiber <input checked="" type="checkbox"/> Foam <input type="checkbox"/> Feather/Fiber Mix <input type="checkbox"/> Feather	Back cushion	<input type="checkbox"/> Fiber <input checked="" type="checkbox"/> Foam <input type="checkbox"/> Feather/Fiber Mix <input type="checkbox"/> Feather
	COMFORT	Standard Comfort <input checked="" type="checkbox"/>	Firm Comfort <input type="checkbox"/>				
	FUNCTION	Bed <input type="checkbox"/>	Electric motion <input type="checkbox"/>	Motion <input type="checkbox"/>	Recliner <input type="checkbox"/>	Sliding <input type="checkbox"/>	
	OPTIONS	Nails <input type="checkbox"/>	Contrast Stitching <input type="checkbox"/>	Removable <input type="checkbox"/>			

NOTES

- Designer: Michele Menescardi
- LEATHER: Model is available with articles Status, Stromboli, Siena and Nubuk.
- Comfort >> The mix of padding in polyurethane and Climalight (special latest-generation silicone microfibre) guarantees a look and support that does not change over time.
- To allow modularity, the single elements can be put together thanks to the rubber stops under the legs.
- Tight Seat Cushion (the seat cushions of the models are fixed to the frame)
- Tight Back Cushion (the back cushions of the models are fixed to the frame)
- With Leather Side (the sectional pieces come with leather sides)
- With Feet Assembled (the model will be loaded with feet already mounted on the sofa)
- Plastic Wrap (the model will be wrapped in a plastic bag)
- Hidden no-scratch and no-slip metal feet.
- Feet available in metal finishing 78 (Black Chrome)

NOTES
