



■ Vers. 450+338+452



■ Vers. 450+338+452



■ Vers. 450+452





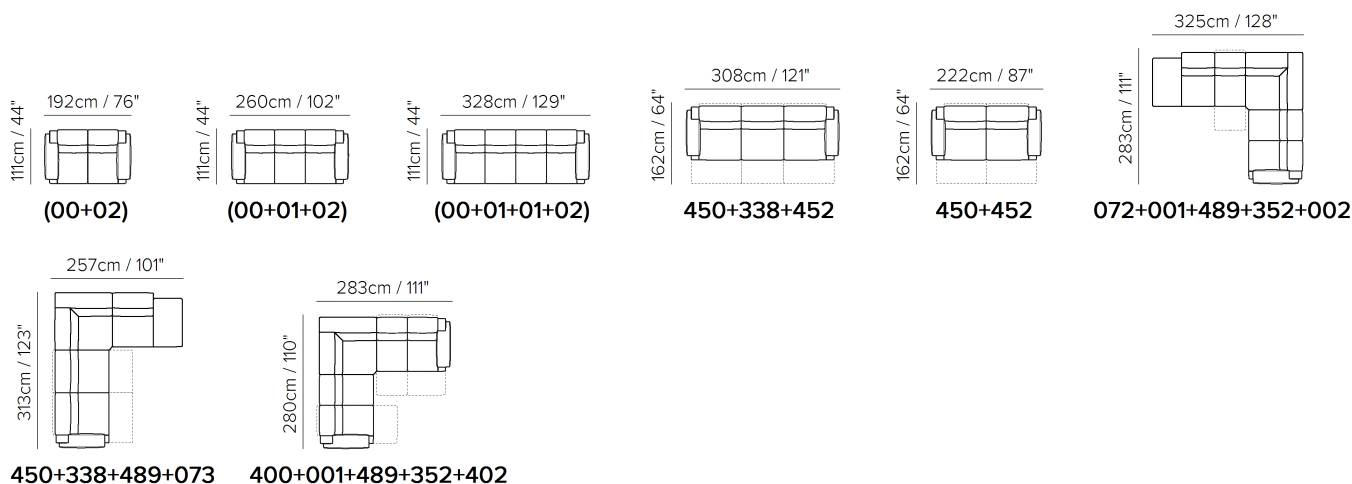

SCHEMATICS



COMPOSITION EXAMPLES



TECHNICAL INFORMATION

	COVERING	Leather <input checked="" type="checkbox"/>	Soft Cover <input checked="" type="checkbox"/>			
	LEGS	Wood <input type="checkbox"/>	Metal <input type="checkbox"/>	Plastic <input checked="" type="checkbox"/>	Castors <input type="checkbox"/>	Upholstered <input type="checkbox"/>
	FILLING	Arms <input type="checkbox"/> Fiber <input checked="" type="checkbox"/> Foam <input type="checkbox"/> Feather/Fiber Mix <input type="checkbox"/> Feather	Seat cushion <input type="checkbox"/> Fiber <input checked="" type="checkbox"/> Foam <input type="checkbox"/> Feather/Fiber Mix <input type="checkbox"/> Feather	Back cushion <input type="checkbox"/> Fiber <input checked="" type="checkbox"/> Foam <input type="checkbox"/> Feather/Fiber Mix <input type="checkbox"/> Feather		
	COMFORT	Standard Comfort <input checked="" type="checkbox"/>	Firm Comfort <input checked="" type="checkbox"/>			
	FUNCTION	Bed <input type="checkbox"/>	Electric motion <input checked="" type="checkbox"/>	Motion <input checked="" type="checkbox"/>	Recliner <input type="checkbox"/>	Sliding <input type="checkbox"/>
	OPTIONS	Nails <input type="checkbox"/>	Removable <input type="checkbox"/>	Contrast Stitching <input type="checkbox"/>		

NOTES

- The square and linear shapes of Iago combine in perfect harmony with the softness of the padding and give it a pleasantly surprising appearance.
- The particularly low seating offers comfort and aesthetic appeal.
- Beauty meets innovation in this sofa: in fact the recline system ensures maximum comfort with the adjustable footrest and headrest, adaptable to your individual needs.
- The exceptionally crafted "pinched" seams frame the padding and set off the coverings. Thanks to these features Iago is an exceptional sofa ideal for enhancing living and family rooms.
- Available with Soft Touch mechanism that changes the seat and back cushion position with a simple tap.
- The model has internal soft touch buttons on the arm to activate the mechanism.
- Model has power combined headrest. ATTENTION! The headrest opens first followed by the footrest; then the headrest has one final extra rotation for comfortable TV watching position.
- Stationary versions have manual headrests.
- Thanks to ZeroWall mechanism, seat and back cushions can be reclined at a great length without moving sofa away from the wall.
- Seat cushion includes a layer of memory foam, a pressure-sensitive soft polyurethane, that recovers its form completely thus giving great comfort.
- Second option version corner 489 has both headrests adjustable.
- Tight Seat Cushion (the seat cushions of the models are fixed to the frame)
- Tight Back Cushion (the back cushions of the models are fixed to the frame)

NOTES

- No Leather Side (the sectional pieces have the side covered with fabric and not leather)
- Wood Frame
- Without Feet Assembled (the feet will be in a bag inside the package)
- Plastic Wrap (the model will be wrapped in a plastic bag)
- Feet height 5,0 cm